

Electrical Specification

Items	Spec	UNIT
Resonance type	TE 01 δ mode	UNIT
Center Frequency (MHz)	1852.5	MHz
Tunning Range (MHz)	1842.5 ~ 1862.5	MHz
Dielectric Constant(ξ_r)	44.5 \pm 1.5	
Q Value (Qu)	12,000	min.
Max temp Drift (τ_f)	\pm 200	khz
Water Absorption (%)	0.01	max.
Operating Temp. Range	-40 $^{\circ}$ C to +85 $^{\circ}$ C	
Support Composition	Al ₂ O ₃ (Er:9.4~9.8)	

Mechanical Specification

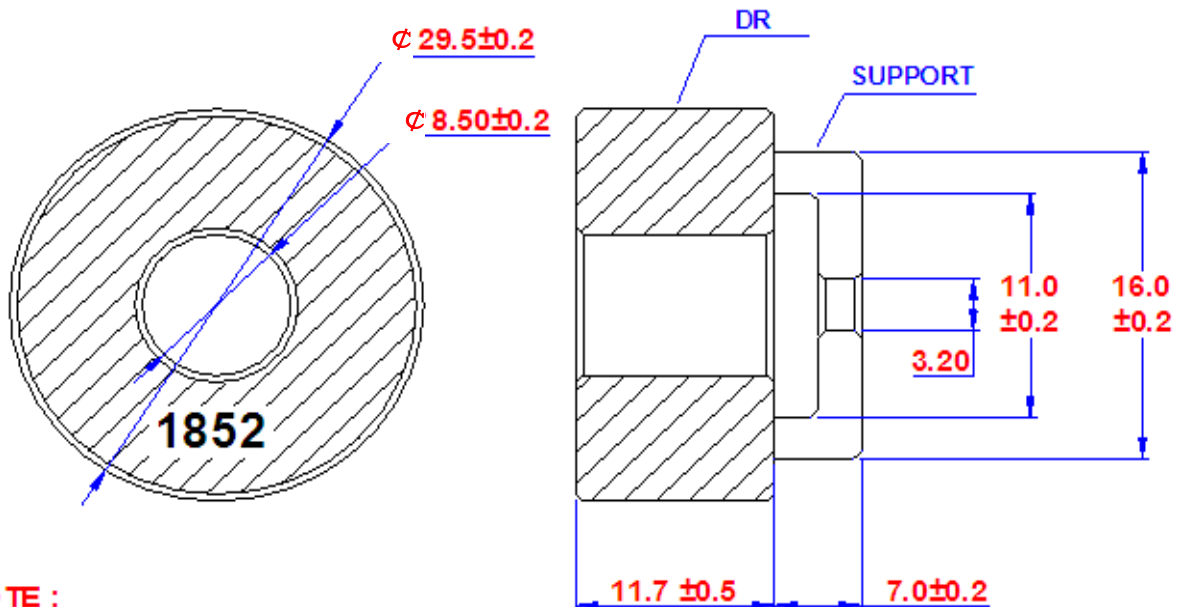

NOTE :
Material specifications
Er = 44.5 \pm 1.5
Unit: mm

Plot Data

