

Electrical Specification

Items	Spec	Unit
Frequency Range	1590 ± 3	MHz
VSWR (at Center Frequency)	1.5	max.
Bandwidth in 10dB		MHz min.
Polarization	R.H.C.P	
Gain at Zenith	1	dBi
Ground plane	50 x 50	mm
In/Out Impedance	50 Ω	
Operation Temp. Range	-40°C to +85°C	

Mechanical Specification

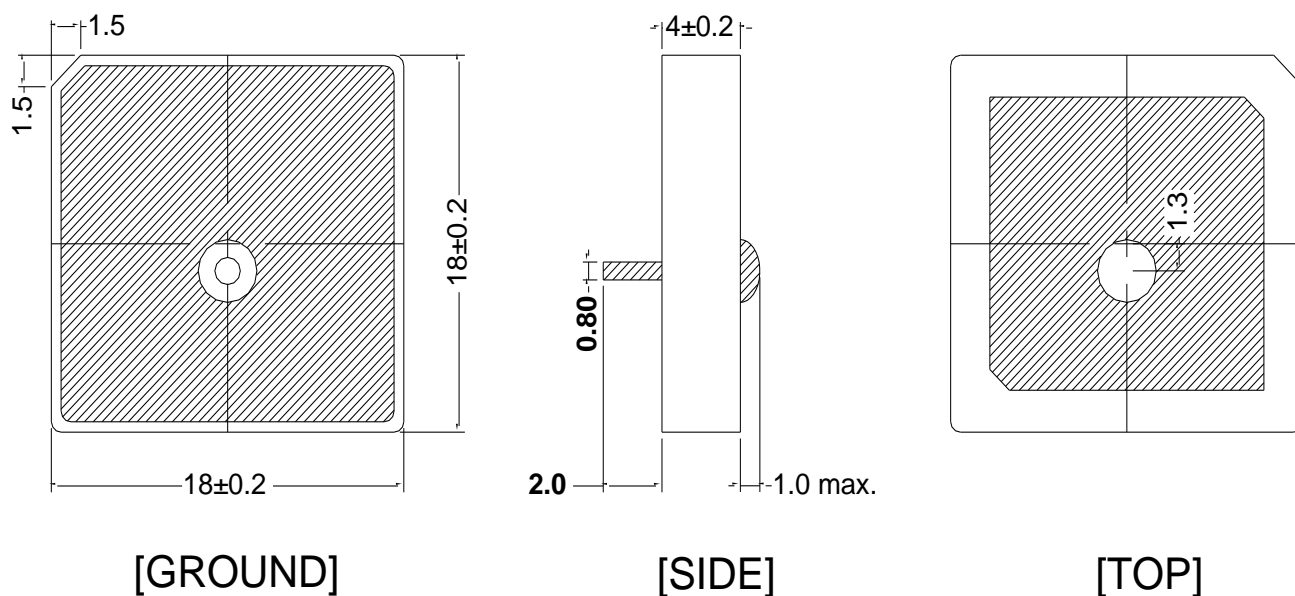

Other Specified Tolerance : ± 0.10
Unit:mm

Plot Data

