

Electrical Specification

Items	Spec	Unit
Frequency Range	1207 ± 3	MHz
Return Loss in fo	15	dB min.
Bandwidth in 10dB	5.0	MHz min.
Polarization	R.H.C.P	
Gain at Zenith		dBi
Ground plane	70 x 70	mm
In/Out Impedance	50 Ω	
Operation Temp. Range	-40°C to +85°C	

Mechanical Specification

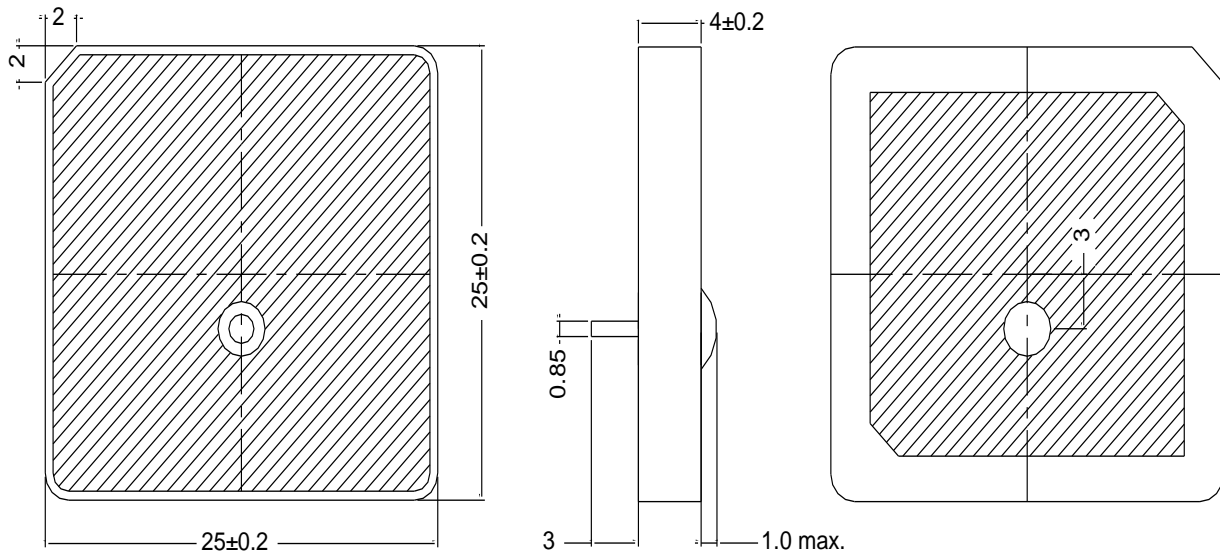

[BOTTOM]

[SIDE]

[TOP]

Tolerance Unless
Otherwise Specified: ± 0.10
Unit:mm

Plot Data

