

Electrical Specification

Items	Spec	Unit
Frequency Range	2338 ± 5	MHz
VSWR (at Center Frequency)	1.5	max.
Bandwidth in 10dB	50.0	MHz min.
Polarization	L.H.C.P	
Gain at Zenith		dBi
Ground plane	240 x 240	mm
In/Out Impedance	50 Ω	
Operation Temp. Range	-40°C to +85°C	

Mechanical Specification

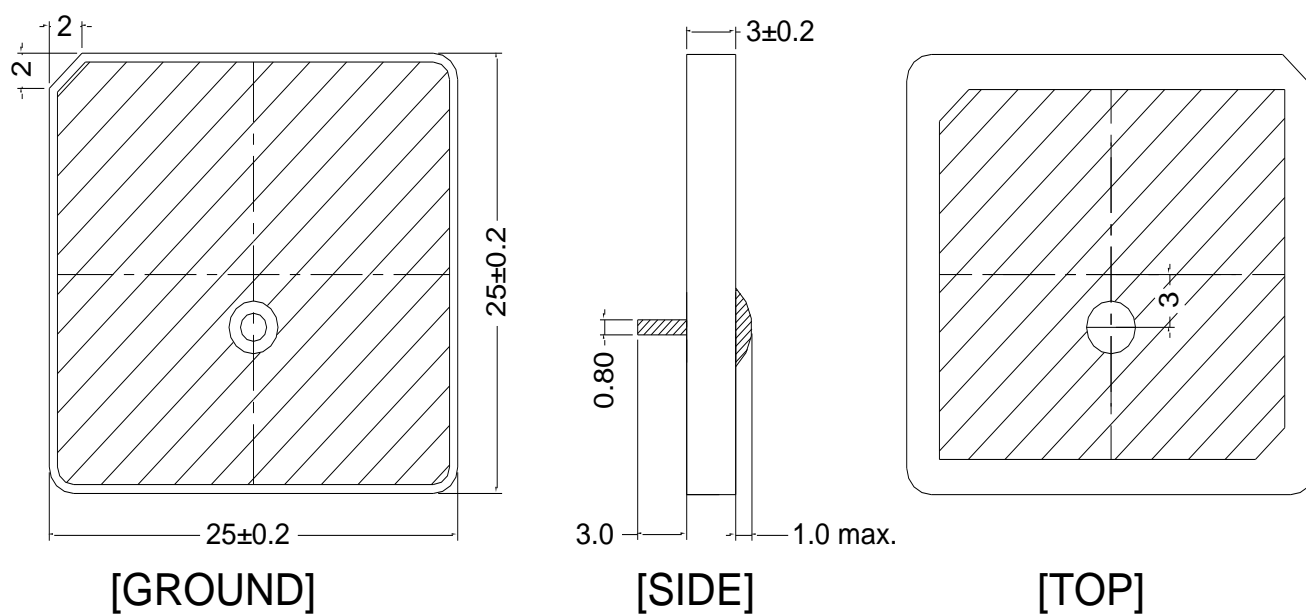

Other Specified Tolerance : ± 0.10
Unit:mm

Plot Data

